















MONTAGEANLEITUNG

-  MONTAGEANLEITUNG
-  ASSEMBLY INSTRUCTION
-  DE INSTRUCTIE VAN DE ASSEMBLAGE
-  ISTRUZIONI DI MONTAGGIO
-  INSTRUCCIÓN DE ASAMBLEA
-  INSTRUCTION DE MONTAGE
-  NÁVOD K MONTÁŽI
-  MONTERINGSANVISNING

-  MONTAJ TALIMATI
-  ASENNUSOHJE
-  BRUGSANVISNING
-  BRUKSANVISNING
-  UPUTE ZA MONTAŽU
-  NAVODILA ZA MONTAŽO
-  SZERELÉSI ÚTMUTATÓ
-  INSTRUCTIUNI DE MONTAJ

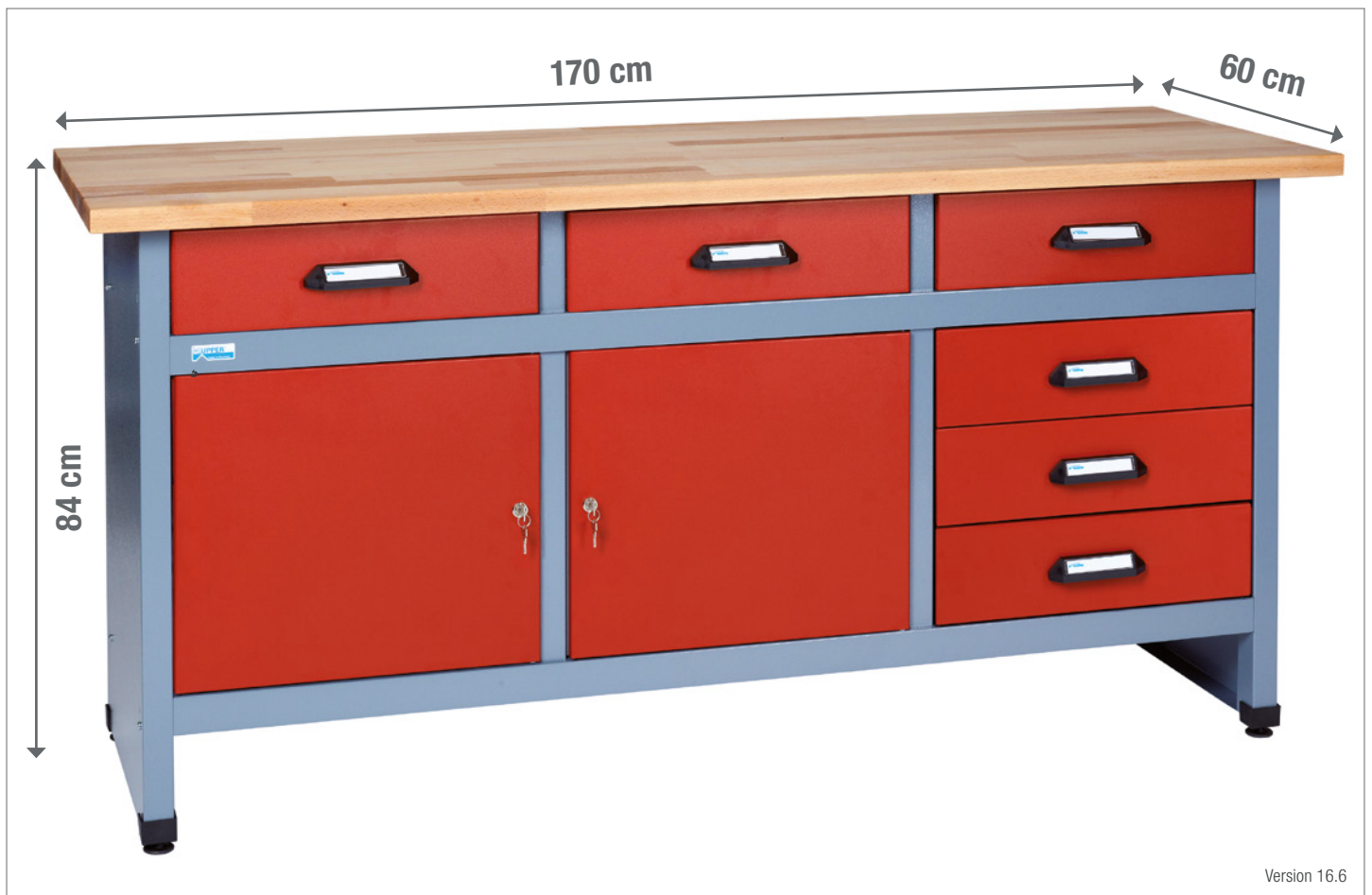

Modell-Nr.

12170

ART.-NR. FRONT KORPUS

12172

Rot
(ähnl. RAL 3002)

Silber

12177

Ultramarinblau
(RAL 5002)

Silber

12176

Silber

Schwarz
(RAL 9005)

Friedrich Küpper GmbH
Friedrich-Küpper-Weg
54570 Berlingen
Deutschland

Telefon +49 (0) 65 91 - 95 42 0
Telefax +49 (0) 65 91 - 95 42 17
E-Mail info@friedrich-kuepper.de
Internet www.friedrich-kuepper.de

EINZELTEILE / PIECES

1× **A**

772 mm × 475 mm

Art.-Nr. E0154 (Silber/silver)
Art.-Nr. E0155 (Schwarz/black)



1× **C**

1570 mm × 473 mm

Art.-Nr. E0179 (Silber/silver)
Art.-Nr. E0180 (Schwarz/black)



1× **B**

772 mm × 475 mm

Art.-Nr. E0165 (Silber/silver)
Art.-Nr. E0166 (Schwarz/black)



1× **D**

1570 mm × 473 mm

Art.-Nr. E0191 (Silber/silver)
Art.-Nr. E0192 (Schwarz/black)



2× **F**

645 mm × 450 mm

Art.-Nr. E0211 (Silber/silver)
Art.-Nr. E0212 (Schwarz/black)



1× **E**

1500 mm × 480 mm

Art.-Nr. E0200 (Silber/silver)

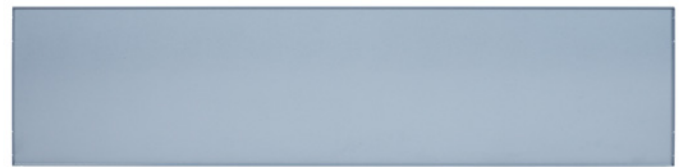

2× **K**

403 mm × 468 mm

Art.-Nr. E0230 (Silber/silver)
Art.-Nr. E0227 (Rot/red)
Art.-Nr. E0229 (Blau/blue)



1× **Y**

1700 mm × 600 mm

Art.-Nr. E0257



2× **L**

400 mm × 25 mm

Art.-Nr. E0233 (Silber/silver)
Art.-Nr. E0234 (Schwarz/black)



6× **J**

450 mm × 120 mm

Art.-Nr. E0224 (Silber/silver)



6× **H**

450 mm × 445 mm

Art.-Nr. E0215 (Silber/silver)



6× **I**

470 mm × 130 mm

Art.-Nr. E0221 (Silber/silver)
Art.-Nr. E0218 (Rot/red)
Art.-Nr. E0220 (Blau/blue)

















6× **X**

450 mm × 20 mm

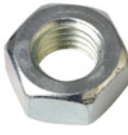

Art.-Nr. E0252 (Schwarz/black)



BEUTELINHALT / BAG CONTENT

 8x 5,5 x 19 mm Art.-Nr. E0284	 16x KU 4 x 16 mm Art.-Nr. E0285	 24x M5 x 10 mm Art.-Nr. E0286	 24x ø5,3 mm Art.-Nr. E0287	 24x M5 Art.-Nr. E0288	 48x M4 x 10 mm Art.-Nr. E0289
 48x M4 Art.-Nr. E0290	 2x Art.-Nr. E0292	 2x Art.-Nr. E0291	 4x Art.-Nr. E0293	 4x Art.-Nr. E0294	 4x M8 Art.-Nr. E0295
 6x Art.-Nr. E0296	 2x Art.-Nr. E0297	 4x Art.-Nr. E0298			

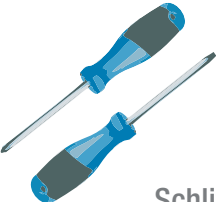
BENÖTIGTES WERKZEUG / NEEDED TOOLS

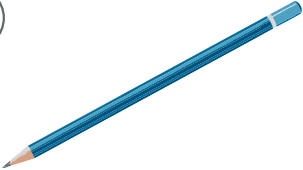
<p>①</p>  <p>PH1 x 100 PH2 x 100 Schlitz 6,5 x 150</p>	<p>②</p>  <p>SW7 SW8 SW10</p>	<p>③</p>  <p>4 mm</p>
<p>④</p> 	<p>⑤</p> 	<p>⑦</p> 
<p>⑧</p> 		

1. WICHTIG / IMPORTANT



2.

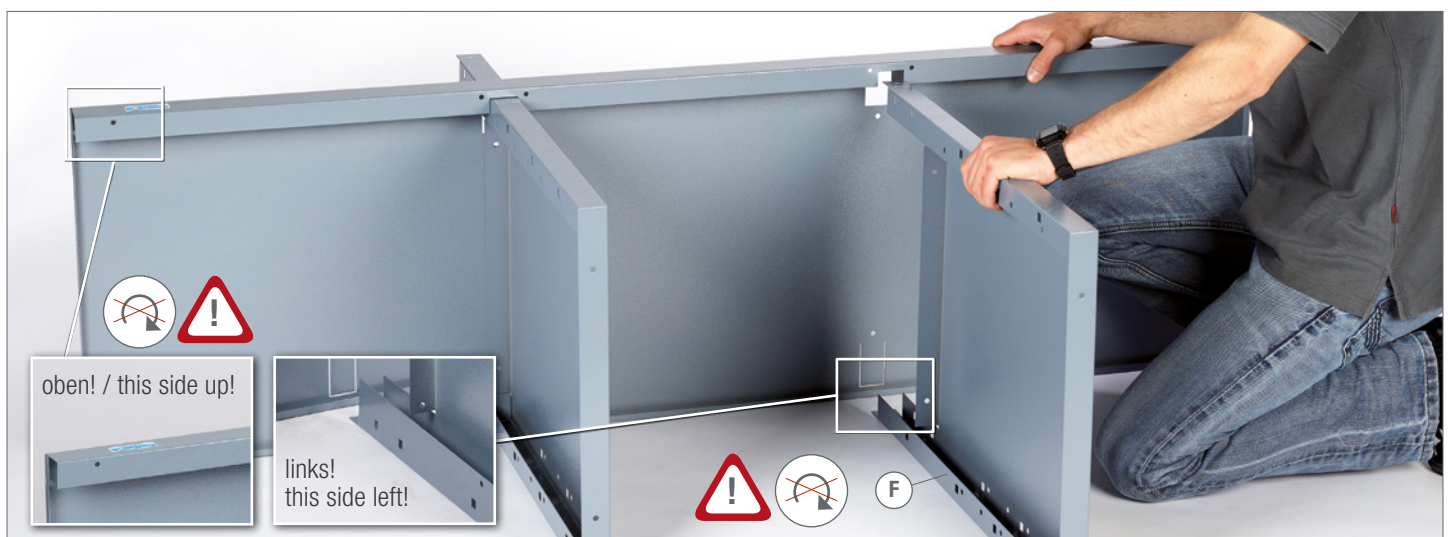

3.  4x M5  4x M5x10  4x 5,3MM

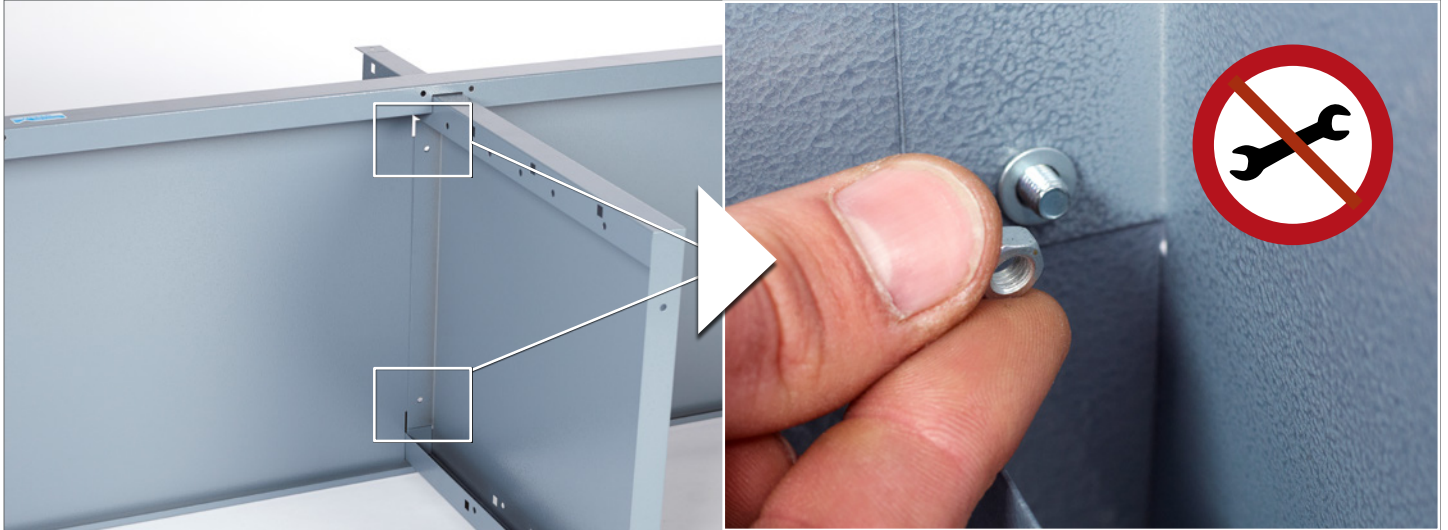

4.



5.  4x M5  4x M5x10  4x 5,3MM  ② SW 8  ① PH2x100



6.



7.

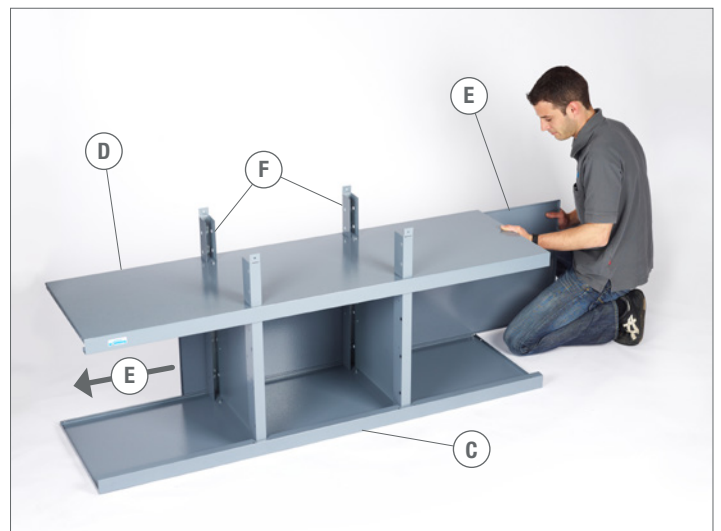

ZU SCHRITT 3. / IN ADDITION TO STEP 3.

②  SW 8 ①  PH2 × 100

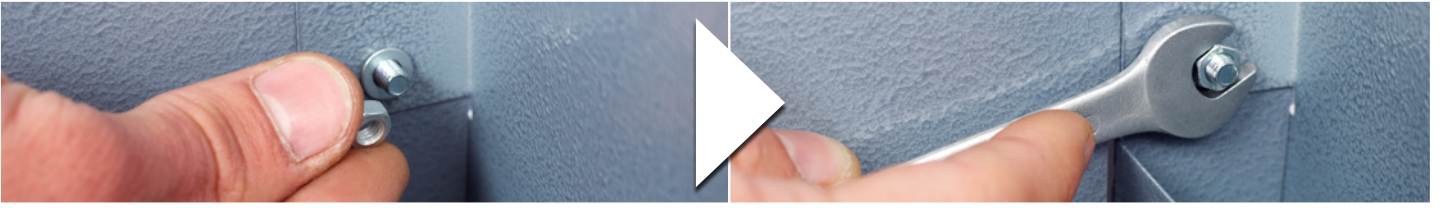

8. WICHTIG / IMPORTANT



9.  6 × M5  6 × M5 × 10  6 × 5,3 MM ②  SW 8 ①  PH2 × 100



10.  6 × M5  6 × M5 × 10  6 × 5,3 MM ②  SW 8 ①  PH2 × 100



11. 4x M8 4x 4x 4x

5



12. 4x KU4x16 2x

1 PH2x100

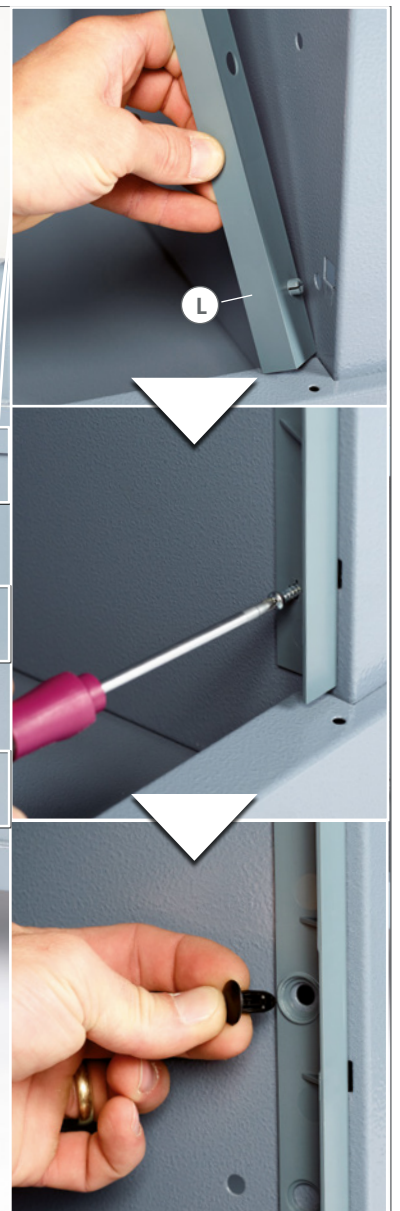

13.



14.

8 7



15.

4 3



16.

8x 5,5 x 19

2 SW 8



17.

4 x



18.



19.



20.

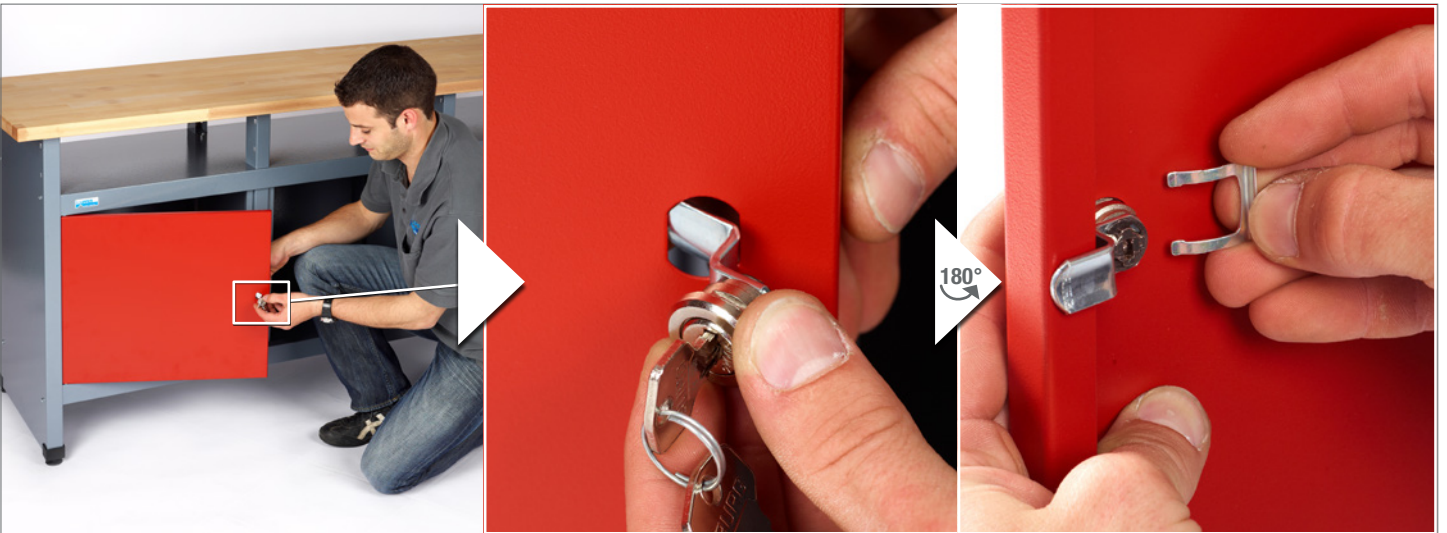

21.

6x CR



22.

6x CL



23.

12x M4

12x M4 x 10

②  SW7

①  PH1 x 100

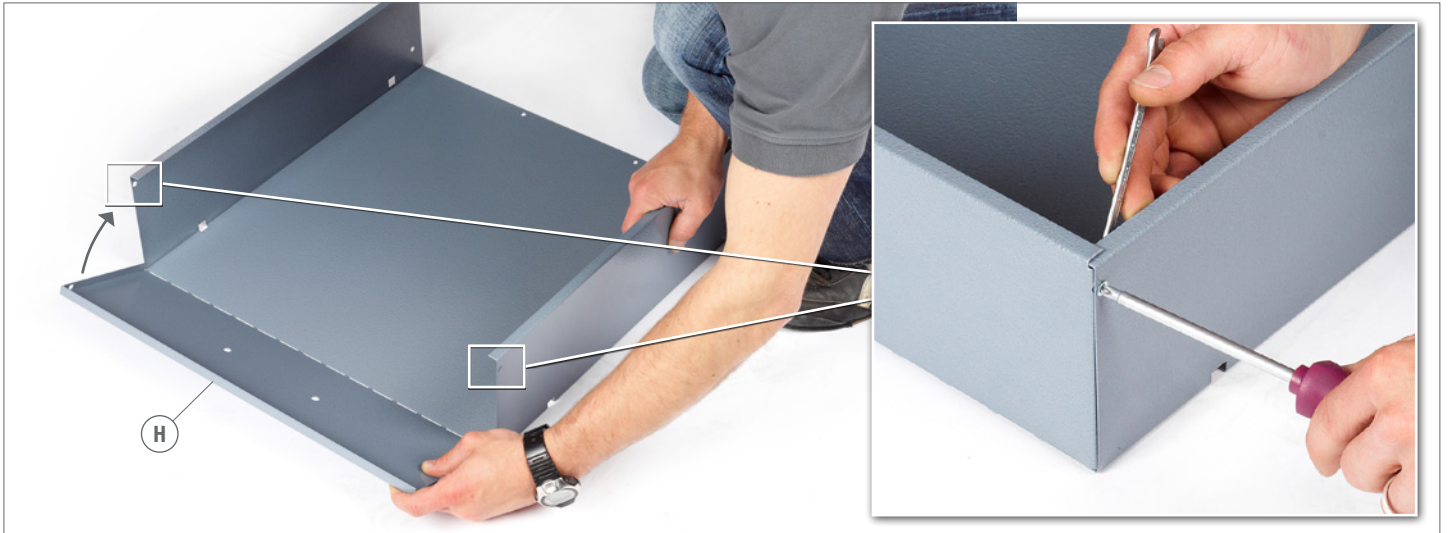

24.

36x M4

36x M4 x 10

②  SW7

①  PH1 x 100

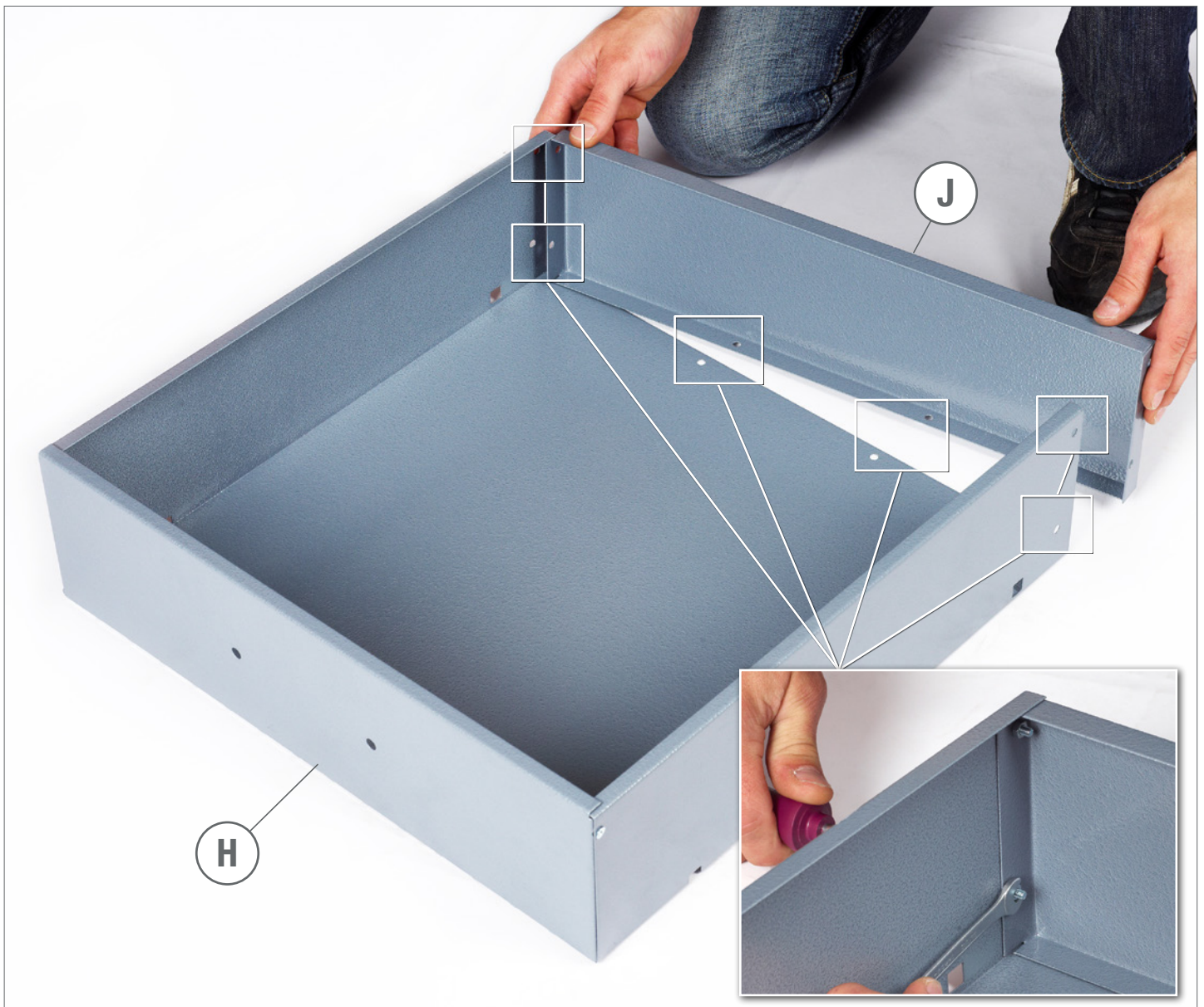

25.

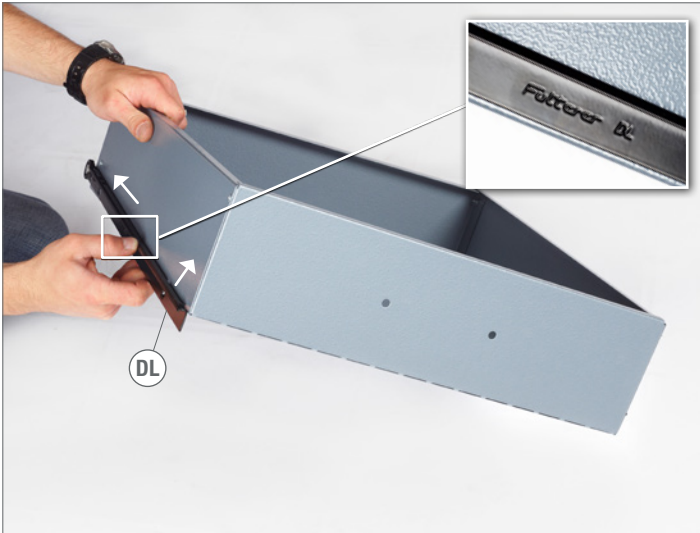

26.

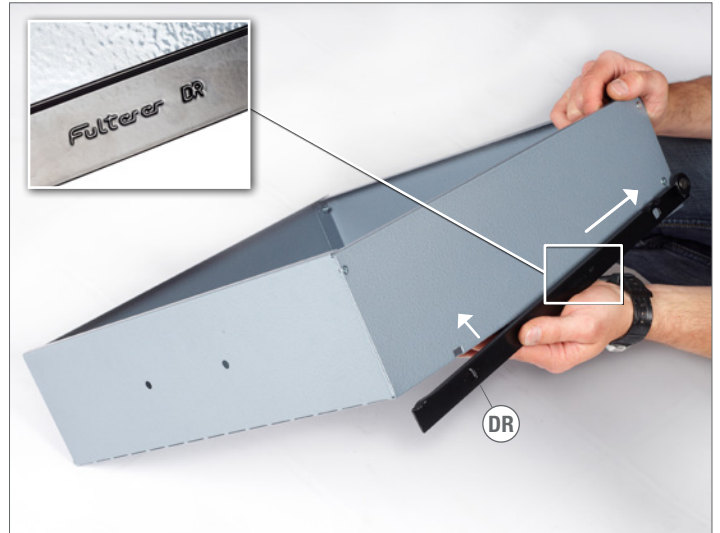

27.



28.

12x KU4 x 16 6x  ①  PH2 x 100



29.



30.

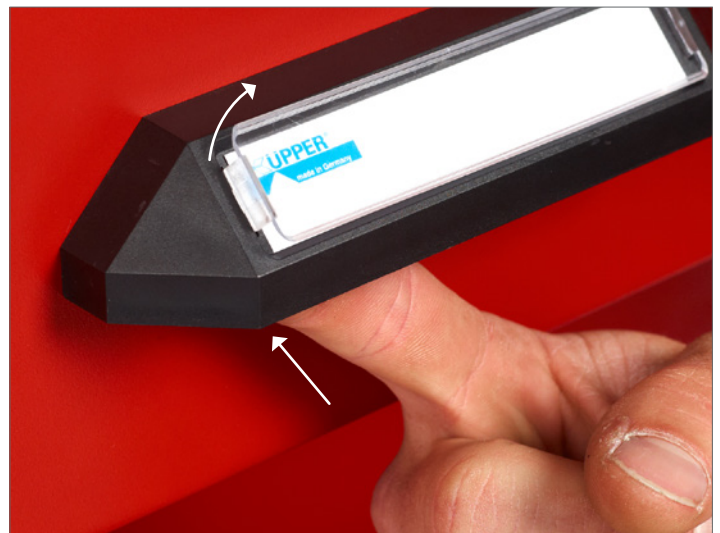



Modell-Nr.

12170